

## Area of a Circle

---

### Grade 5 Geometry Worksheet

Calculate the area of each circle.

1.

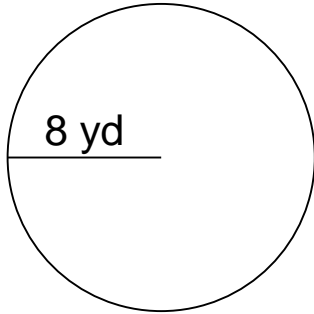

2.

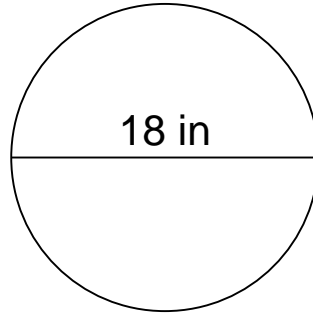

3.

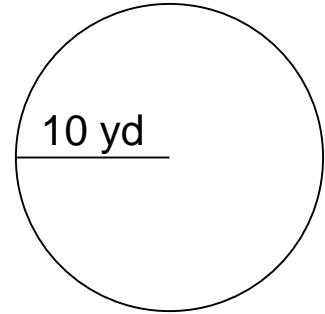

4.

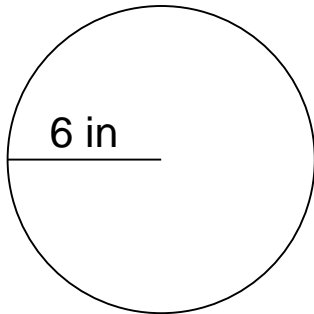

5.

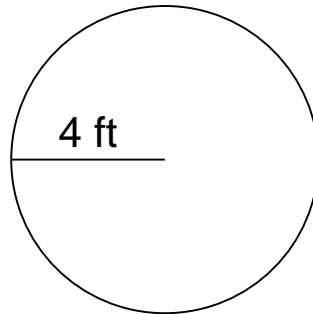

6.

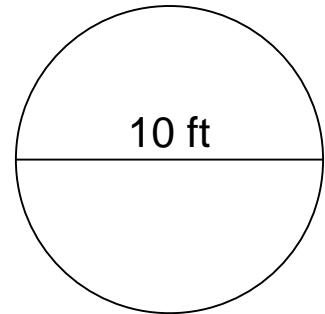

7.

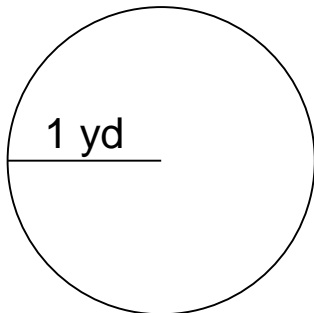

8.

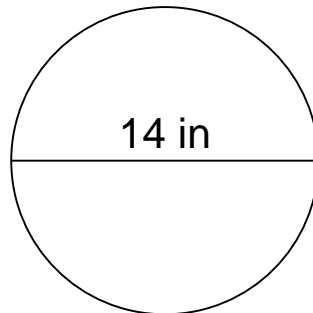

9.

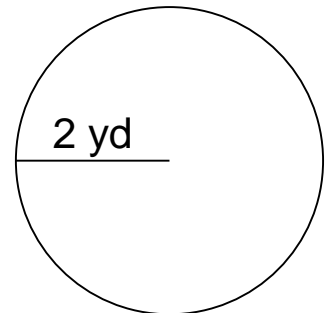

## Area of a Circle

---

### Grade 5 Geometry Worksheet

Calculate the area of each circle.

1.

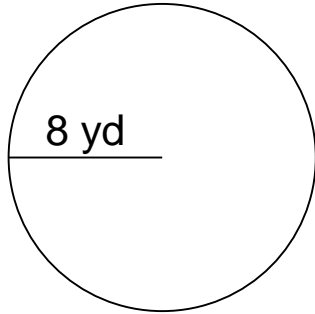

$A=200.96 \text{ yd}^2$

2.

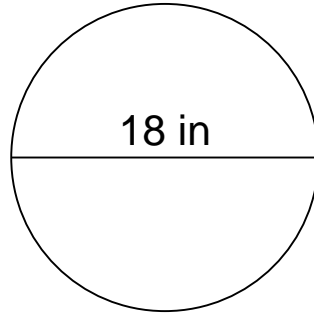

$A=254.34 \text{ in}^2$

3.

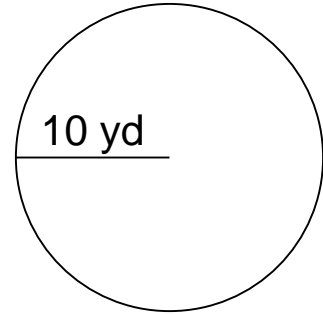

$A=314.00 \text{ yd}^2$

4.

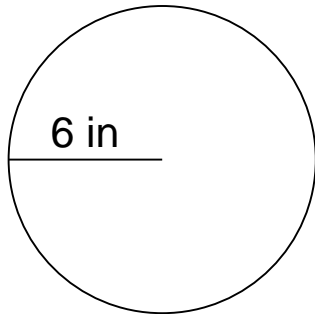

$A=113.04 \text{ in}^2$

5.

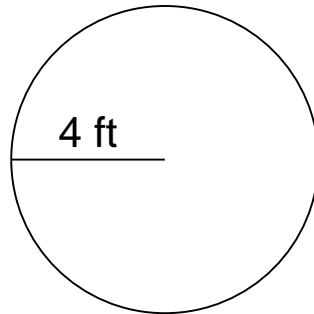

$A=50.24 \text{ ft}^2$

6.

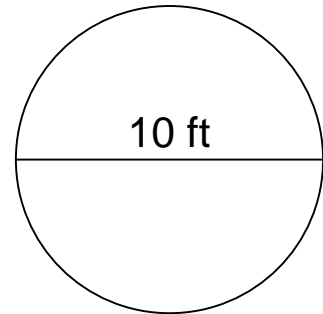

$A=78.50 \text{ ft}^2$

7.

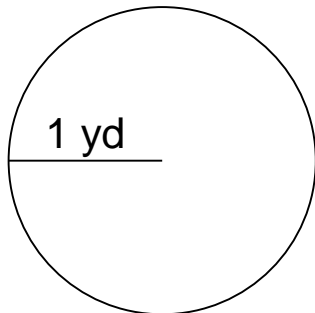

$A=3.14 \text{ yd}^2$

8.

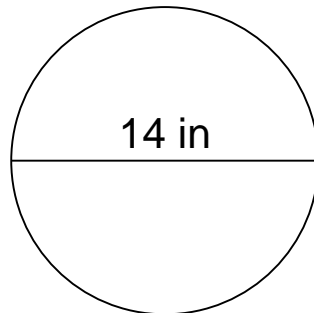

$A=153.86 \text{ in}^2$

9.

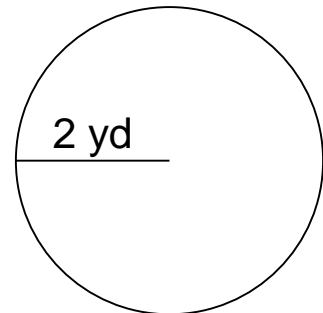

$A=12.56 \text{ yd}^2$